

Chapter 2: Definitions:



"How much better is it to get wisdom than gold!
And to get understanding rather to be chosen than silver!"
Proverbs 16:16.

Definitions

GOD: "In the beginning, God created." Genesis 1:1.
The greatest creative power possible. "God is love."
I John 4:8. Further definition is up to each individual.



VEGETABLE AND FRUIT JUICES: What healthy politicians serve at parties. The main part of a health food diet.

HEALTH FOOD: Fruits, vegetables, grains, nuts, meat, salads, sprouts. Vitamin, mineral, protein supplements. Minimum grease, sugar, and junk food. The food pyramid published by the government is very good. Vegetarianism is an option but not required.

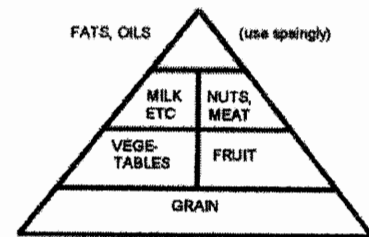

EUGENICS: "Healthy genetics." Ready or not, we are beginning to manipulate genetics, to cure health problems and select qualities of unborn children: sex, body type, intelligence, personality, resistance to disease, like selecting items from a store.

WOMEN'S FASHION INDUSTRY: Primarily controlled by homosexuals, lesbians, and international political conspiracies that all wish to degrade women... The Bible suggests modesty in fashion, and nothing else can empower women more...

CONSPIRACY THEORY: Big money plus alcohol plus politics = conspiracy. It is usually combined with big lies and name calling, like bees in a beehive. "No one is here, except us bees buzzing around the honey pot" (so go away and leave us alone, you blankety blankety blank).

GENE POOLS: A group of animals or humans that tend to interbreed. The ideal size of a gene pool may vary from ten thousand to two or three million, according to various theories. One animal theory states that 99.7 percent of the members should breed back into the gene pool, while two or three out of a thousand should mix with similar gene pools, for maximum benefit and minimum genetic debris from too much in-breeding or too much out-breeding. Humans are similar.

NATURE OF THE COSMIC ORDER: *Scientific American* has had an article claiming the cosmic order is based on intelligence, that material is controlled by intelligence. It is only a small step from saying a Higher Intelligence controls everything.

Dualities in nature

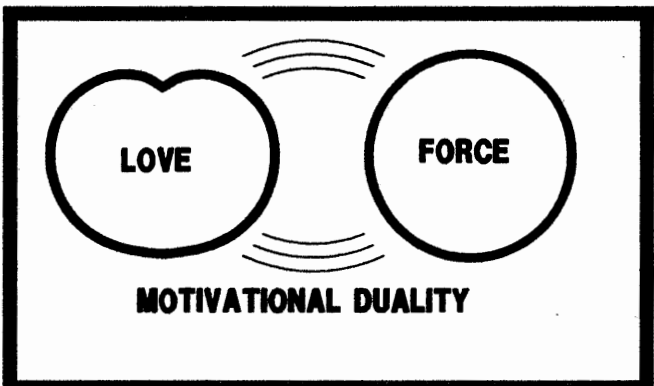
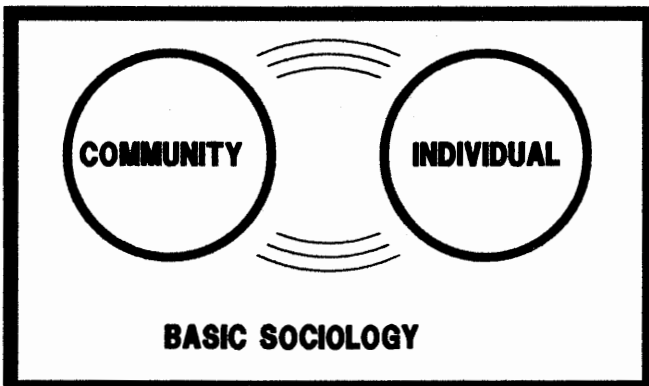
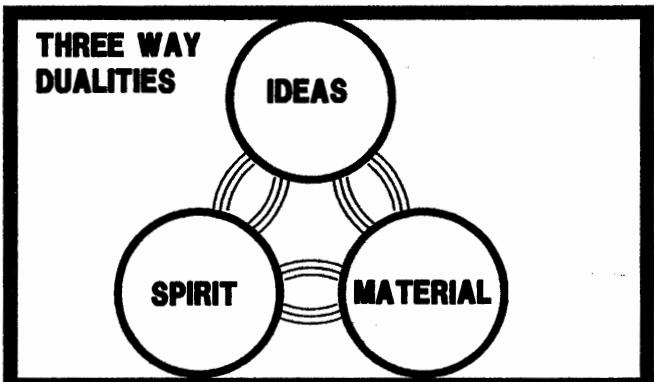
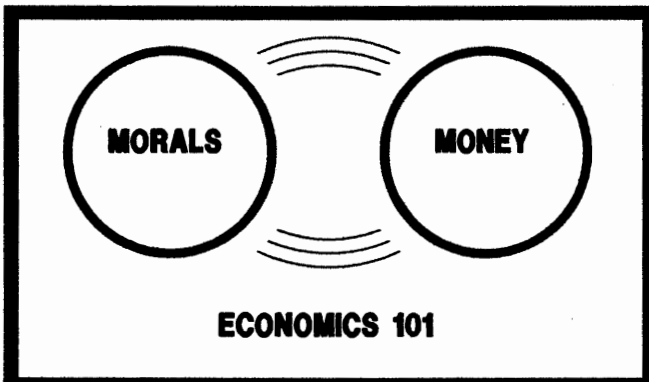
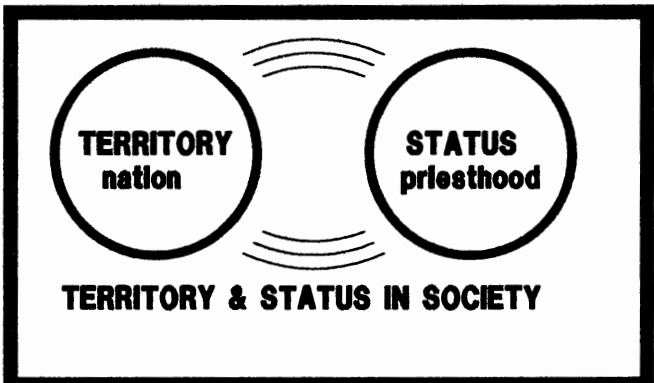
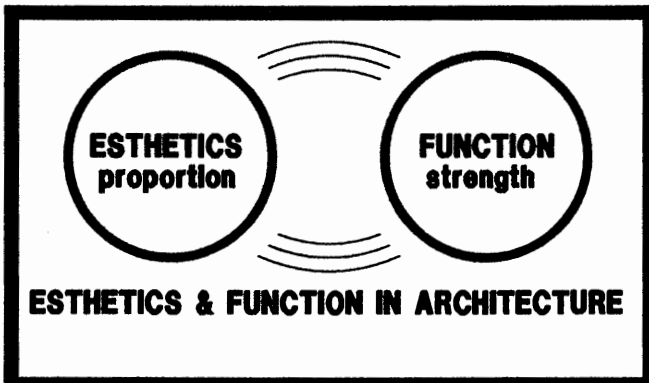
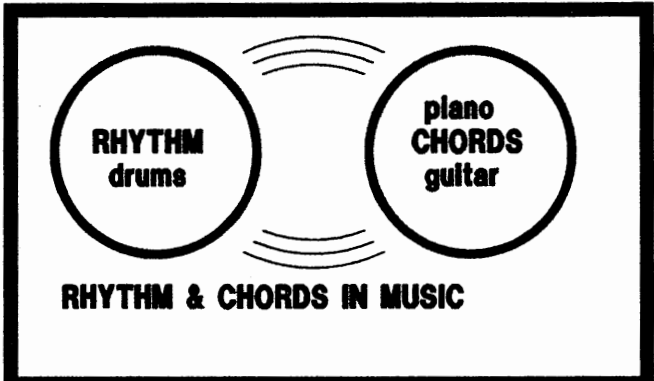
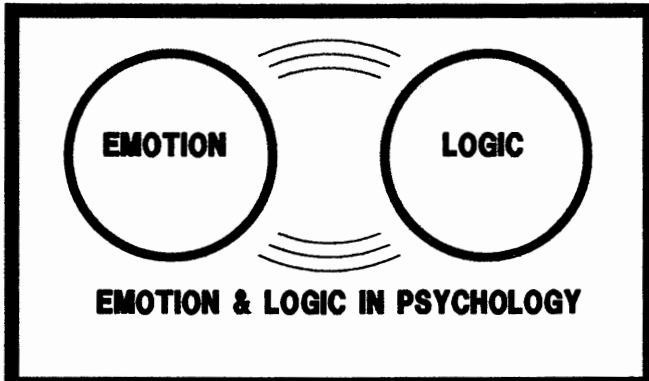

Dualities in nature

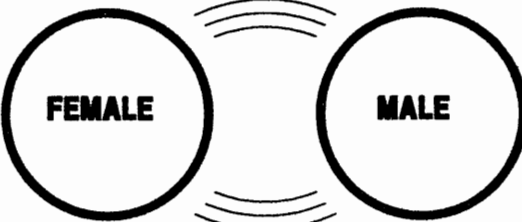

FEMALE **MALE**

**FEMALE & MALE IN BIOLOGY,
AND IN THE IMAGE OF GOD**

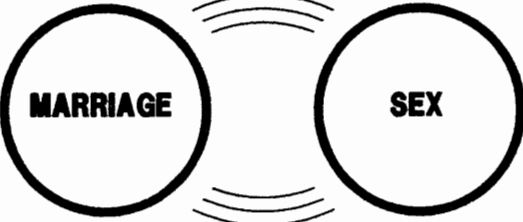

MARRIAGE **SEX**

**MORALITY & PLEASURE
MARRIAGE IS HONORABLE IN ALL**

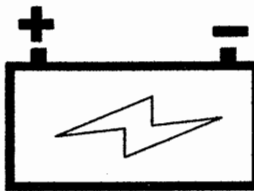

POSITIVE--NEGATIVE ELECTRICITY

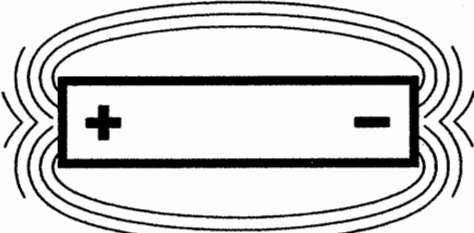

NORTH-SOUTH POLES ON A MAGNET

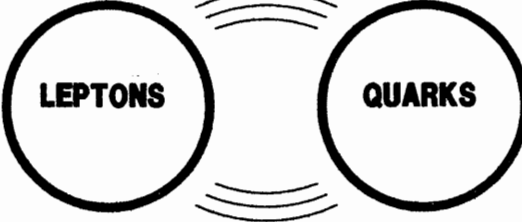

LEPTONS **QUARKS**

DUALITIES IN SUB-ATOMIC PARTICLES

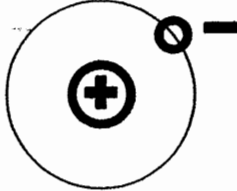

PROTONS AND ELECTRONS IN ATOMS

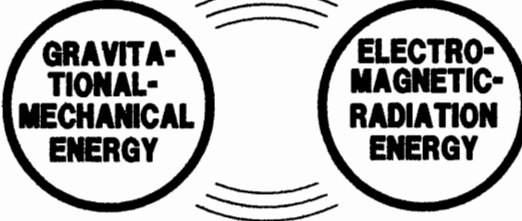

**GRAVITA-
TIONAL-
MECHANICAL
ENERGY** **ELECTRO-
MAGNETIC-
RADIATION
ENERGY**

DUALITIES IN ENERGY EQUATIONS

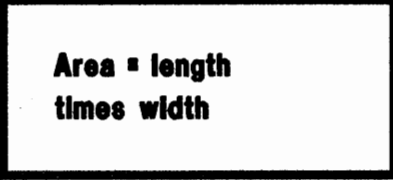

**Area = length
times width**

**GEOMETRY AND NUMBERS IN
GEOMETRIC-MATHEMATICS**

DEFINITIONS:

Marriage:

A BASIC DEFINITION: One mate for life ideal, one male, one female, similar to the north-south poles on a magnet...

BIBLICAL DEFINITIONS: "God made them male and female. For this cause shall a man leave his father and mother, and cleave to his wife." Mark 10:6,7. "Marriage is honorable in all, and the bed undefiled." Hebrews 13:4

GENERAL BENEFITS: On average, married people live longer, make more money, and pass more wealth to their children... Married people and their children are much less likely to be the victims of physical and sexual violence... There are low rates of sexually transmitted diseases among married people...

ANIMAL EXAMPLES: Many animal species form a "pair-bond" for life, and it often involves a "pair-territory", such as eagles, hawks, mockingbirds, geese, arctic wolves, gray foxes, mink, beavers, gibbons, and a few baboon troops... (Reference: *Territorial Imperative*, Ardrey)

MARRIAGE: ECONOMIC AND POLITICAL ASSOCIATIONS: Marriage, middle class economics, and political nationalism all tend to go together, and it is difficult to separate them... Marriage is an essential part of a healthy, middle class society...

FREE SEX: ECONOMIC AND POLITICAL ASSOCIATIONS: Free-sex, extremes of wealth and poverty, crime, disease, social mayhem, international rip-offs and political tyranny all tend to go together, and it is difficult to separate them...

FREE SEX: ASSOCIATIONS WITH ALCOHOL AND DRUGS: There are increased associations with alcohol, smoking, drugs, which further tend to increase disease, crime, physical and sexual abuse, welfare, and poverty...

BEWARE: Anything which promotes free-sex, and attacks the family, such as "popular music", TV, Hollywood, Wall Street, Marxism, etc, is an attack on middle class living, and tends to return society to the ancient oppressions of feudalism, with a few rich, and many poor, and the rich continually feuding and fighting among themselves...

BEWARE: A single mother and her children are seven times more likely to live in poverty than a married woman, and 17 to 40 to 60 times (depending on the study) more likely to be the victims of physical and sexual violence and abuse.

DEFINITIONS:

**Marriage, family:
one-mate-for-life,
children**



**An essential part of a
healthy society**

DEFINITIONS:

CLANS: An ancient system of extended families... Clans have been under attack since the Roman Empire, because they limit the power of wealthy families and governments. The clan, like the family, is a source of power, available for all citizens...



CIVIL RIGHTS VERSUS GOD GIVEN RIGHTS: Rights and responsibilities come primarily from God and the laws of nature. "Civil rights", given by government bureaucrats, are essentially a fraud for any issues of major importance...

LOSING YOUR MARBLES: Marriage is like a box of marbles, and sex is like the marbles. If the box breaks down, a person can spend the rest of their life chasing the marbles: divorce, child support, violence, standing in a welfare line, disease, AIDS,...

MARRIAGE: One mate for life, one male, one female... "God made them male and female. For this cause shall a man leave his father and mother, and cleave to his wife." Mark 10:6,7.

TERRITORY: "Go in and possess the land." Deuteronomy 1:8. A basic instinct, nearly as basic as sex, according to *Territorial Imperative*. Has been found to double an animals power in some experiments. Examples are family homes, family farms, and nationalism. The instinct for territory, like other forms of morality, is damaged by alcohol and drugs. Is opposed by international bankers and communism for everyone but themselves. Territory, like marriage, is a source of power available to all citizens.

MULTI-CULTURALISM: Wealthy groups practice a strict racial, class, and cultural segregation for themselves, and promote multi-culturalism for others, to have cheap wages, mock the poor, and play divide and conquer. There are healthy forms of multi-culturalism, but beware the trap set by liberalism and Marxism.

MARXISM: Marx drank too much wine, and wrote a long-winded book which poorly defines his goals. Pretends to be anti-capitalist, but was financed by wealthy bankers. Is against the middle class and also against all forms of national loyalty. A "dictatorship of the workers" quickly becomes a "dictatorship over the workers."

POLITICAL CORRECTNESS: Distinguishes between orthodoxy and heresy in a capitalist-communist "philosophy. Similar to the Inquisition. Started under Stalin in the 1930's, and spread to colleges, governments, and mass media... Is vaguely defined, continually changing, and uses emotional name-calling. You can be guilty of a long list of "thought crimes", "hate speech", and need "political re-education" if you even laugh at the wrong time, defined by "them", of course, which is the whole idea...

DEFINITIONS:

**Clan revival:
Power for all religious
and ethnic groups**

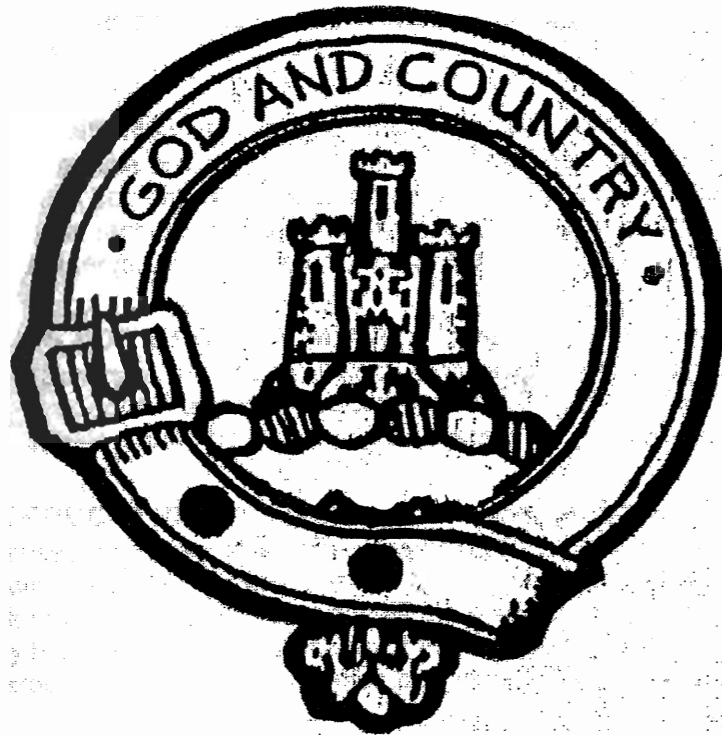

**Anglo-Saxon, German,
Irish, Scottish, Kurdish,
Jewish, Asian, African...**

DEFINITIONS:

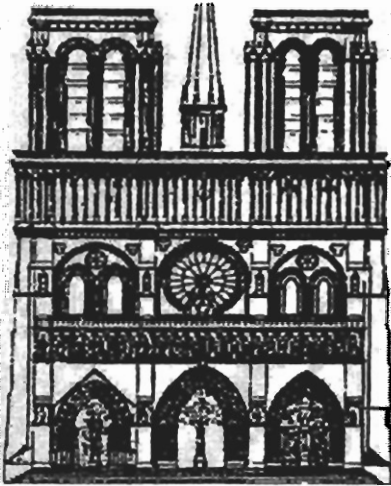

"YOU RACIST": Race until recently has been a "taboo" subject, as though negative, hostile, name calling racism is the only kind possible. However, racism can be both positive or negative, just like a person can use their car to drive to church or to a whorehouse.

Loyalty of a person to their genetic heritage is honorable, and does not mean they have to insult anyone else's. Anyone can appreciate others without being disloyal to their own. In fact, let's encourage the best in all groups and individuals, regardless of race, mixed race, culture, religion. We all have a long way to go, and plenty of room for improvement. Ideals are in the future, not the past...

EATABILITY SCALE: Animals with high sexual morals, as well as those that are big, strong, and fast, are less likely to be eaten. Eagles, hawks, gray wolves, mink, and gibbons are monogamous, and less likely to be eaten.

Cattle, pigs, rabbits, chickens and turkeys are promiscuous, and more likely to be eaten. Also, chickens and turkeys can't fly. You can soar with the eagles, or flop around with the turkeys, soar with the eagles, or join a new world order turkey farm.

The 'liberals' are eager to take real good care of you: MTV, drugs, free sex, rock-n-roll, total rap-crap, ignorance, violence, cheap wages, and a police state...

CAMPAIGN LOGIC: The use of double standards, as in a political campaign. When a politician says, "The other candidate has a negative campaign, and accepts under the table contributions" - when they both do the same.

ENVIRONMENTAL PSYCHOLOGY: It has ancient origins, and includes town planning, architecture, floor plans, interior decorating, sounds, music. It has been used for religious purposes, to inspire higher levels of awareness, to reduce crime, improve behavior, relax medical patients, increase consumer purchasing, and improve romance...

WHAT'S THE OPPOSITE OF "OFF YOUR ROCKER"? A "ROCK-N-ROLLER"? Theory: A healthy person evaluates things – what to do, where to go, what to buy, etc -- by rocking back and forth between intuition and emotion on one side, and logic on the other, like rocking back and forth between two poles of a magnet, until they come to a decision. A person who uses all emotion, or all logic, has lost the power of a two pole magnet, they are "off their rocker"...

Eatability Scale:

Animals with high sexual morals, as well as those that are big, strong, and fast, are less likely to be eaten. Eagles, hawks, gray wolves, mink, and gibbons are monogamous, and less likely to be eaten.

Cattle, pigs, rabbits, chickens and turkeys are promiscuous, and more likely to be eaten. Also, chickens and turkeys can't fly. You can soar with the eagles, or flop around with the turkeys, soar with the eagles, or join a new world order turkey farm.

Conspiracy Theory:

“Free sex”, “promiscuous sex”, “sex outside of marriage” contribute to marriage breakdown and substantially increased social chaos: Increased crime, single parenthood, children out of control, poverty, disease. Social chaos eventually requires a dictator to step in and restore order.

As the totalitarian “progressive liberals” (a deliberate misnomer) openly tell us, never let a crisis go to waste. Can all the people sleeping around learn to say, “Hail, Great Leader! All wise! All knowing!” as they march off to work or perpetual war, at very low wages, or stand in a welfare line.

DEFINITIONS:

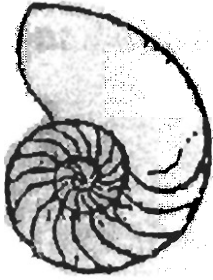

HEALTHY ART: Nature and geometry are basic healthy themes. Art has heavy religious, political, cultural and moral influence. It is good to stay with themes of constructive messages. Garbage art, as promoted by many major universities, should be avoided as an attack on cultural stability. Art is more than esthetics. It is also a religious and political weapon...

BIRD SINGING: Is primarily a territorial claim. In the humming bird, the female only sings when she is on her own territory, a space next to the male's. One bird species, the African bou-bou shrike, pair bonds for life, but does not have a territory: the male and female recognize each other by singing as many as seventeen songs - in the same musical intervals as a human piano. (Reference: *Territorial Imperative*, by Ardrey).

WORDS FOR HEALTHY MUSIC: Music is very influential, and words should almost always reflect basic religious, cultural, political, nationalistic and moral values, or have humor or tell a story with some moral. Words which defy all basic religious and moral values should be avoided like a plague.

SEX EDUCATION: May actually mean what its name implies in some cases, but is often used by certain 'liberal' factions as an excuse to promote free sex, amoral behavior, and family breakdown. Free sex makes people more vulnerable to alcohol and drug abuse, and family breakdown deprives people of a lot of social power and stability, making them vulnerable to those with totalitarian political ambitions.

VALUES CLARIFICATION: Is similar in purpose to sex education, to bring high speed social anarchy, mayhem and collapse, which require a dictator to restore order.

RADICAL FEMINISM AND MARRIAGE: Marriage is a fascist, capitalist, bourgeois, male chauvinist conspiracy to oppress women, children, and the working class. Marriage must be destroyed - according to this Marxist philosophy, with help from Hollywood, Wall Street, the music industry, massive tax exempt foundations and the National Education Association. They oppose marriage because it does empower citizens, and they want all the power, and don't want anyone else to have any.

DEFENSIBLE SPACE: Certain arrangements of cities, streets, parks, hallways, and architecture can substantially reduce crime and empower people: cul-de-sacs, short hallways in apartment buildings, long narrow parks visible from a street, public areas visible from residential areas, good lighting, and territorial arrangements of space all tend to reduce crime and give a sense of ownership and control to the residents. Reference: *Defensible Space*, by Newman.

DEFINITION OF FRUSTRATION:

Cosmo girl meets Playboy:

- It's all about how she should make *him* happy.
Outside of marriage.
- Backwards.
- Amoral.
- The *Cosmo* girl is subservient to *Playboy!*
- It's all part of a communist-capitalist, male chauvinist, anti-family free sex blitz.
- Is the *Cosmo* girl liberated? Ho-ho-ho. No.
Ask any drunken *Playboy*. She works for free in an ancient profession to please *him*.
- It should be about how he can make *her* happy.
After marriage. Sober.

**If mama isn't happy,
nobody is happy.**

NOTE: Free sex increases disease, illegitimate children, single parenthood, a tendency to poverty, crime, abusive boyfriends, frustrated women, social mayhem...

THE BIBLE: HUSBANDS ARE TO PLEASE THEIR WIFE: "So ought men to love their wives as their own bodies. He that loveth his wife loveth himself." Ephesians 5:28

DEFINITIONS:

MAGNETIC BALANCE



MAGNETIC THEORY OF MORALITY: Many social forces have polarity like magnets, such as marriage and sex, emotion and logic, or leaders and followers. These forces tend to work together, and increase and decrease together.

NEMESIS THEORY: A nemesis (persistent opponent) kicks in when morality or balance kicks out. Examples: An electrical imbalance may bring a lightning bolt. Rabbit overpopulation may be an invitation to wolves. Lack of sexual morality may increase disease, crime, war, poverty, dictatorship. If the rich get too much power, they may fight each other, or the peasants or secret police may revolt...

PARALLEL REALITY: "Choose you this day whom ye will serve." Joshua 24:15. 'Liberals' and 'conservatives' have a list of virtues and vices which are often reversed in each system, such as marriage vs. free sex, nationalism vs. internationalism, alcohol and drugs vs. sobriety, family homes vs. welfare... Take your choice.

SCIENTIFIC METHOD: "The heart of the righteous studieth to answer." Proverbs 15:28. Ask a question, research, answer, test, repeat...

A HOUSE OF WISDOM CREATES A HOUSE OF WEALTH: "Through wisdom is a house builded... and by knowledge shall the chambers be filled with all precious and pleasant riches." Proverbs 24:3,4. Examples: House of Windsor, House of Rothschild, House of Rockefeller, Kennedy clan, the Italian fondi (wealthy families)... God help us. We need wiser leading families. In a healthy society, wealth is widely dispersed....

LIMOSINE 'LIBERALS': A would-be over-class who believe in international governments and large corporations -- with no checks and balances. They use big lies if they lack the power to use the army. "It's for the children, the women, the workers, the poor, the immigrants..." Sure. Just as long as they are the only ones with any power. And don't expect them to actually practice what they preach, whether it's "civil rights", the environment, or whatever, it's all for someone else...

BOURGEOIS: The dictionary says it is derived from old French, meaning citizens in a fortified town. Sounds good. Also means the middle class. Gets confused with a capitalist rip-off class in Marxist theory, with its fuzzy minded analysis...

DEFINITIONS:

New education materials

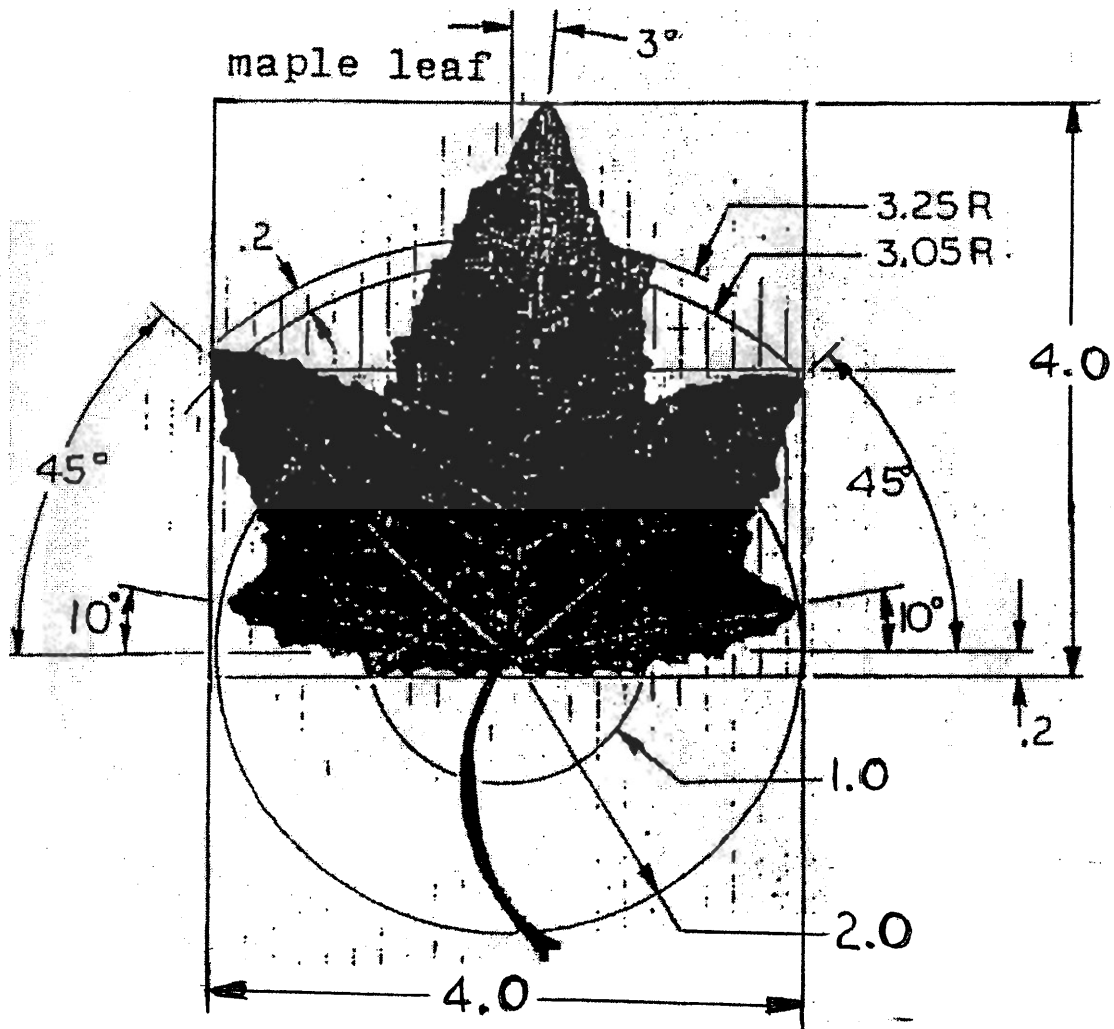

Design with nature

DEFINITIONS:

Golden section

In human proportion...

REFERENCE: *Newsweek*, 8-20-1962

"... French anthropologist turned personnel consultant. For fifteen years, Viard has measured up prospective engineers for Telemecanique Electrique of Nanterre. His method (95 per cent accurate, claims his satisfied client) is based on the Euclid ratio...

This ratio is approximately $1/.618$... the 'golden' proportions so that $1/.618 = 1.618/1$.*

"CENTER OF INTEREST: Artists and architects in early Greece and Rome used the 'golden' relationship to locate the point of interest in a painting and for judging the most elegant proportions for a building. Dr. Viard has found he can get a pretty good idea of a potential employee's worth to a company by using the same classic ratio.

"... the length of a man's thumb... should also be the height of his ear, as well as the distance from the underside of his nose to the base of his chin. The lower joint in the thumb has to be $.618$ of the length of the thumb, and so should the orifice in the ear in relation to the height of the ear... if the distance from the feet to the navel is 1, the distance from the navel to the top of the head must be $.618$..."

*. A ratio that is related to the Fibonacci series, a set of numbers, 1,1,2,3,5,8,13, etc., in which each number is the sum of its two predecessors. The ratios of the adjacent terms of the series tend toward the value $.618$."

...art and architecture

DEFINITIONS:

Optimum design:

"And God saw everything that he had made, and, behold, it was very good." Genesis 1 :31.

The Fibonacci numbers (1,1,2,3,5,8,13,21...) and golden section (.618... and 1.618...) are related to optimum efficiency and most pleasing proportions.

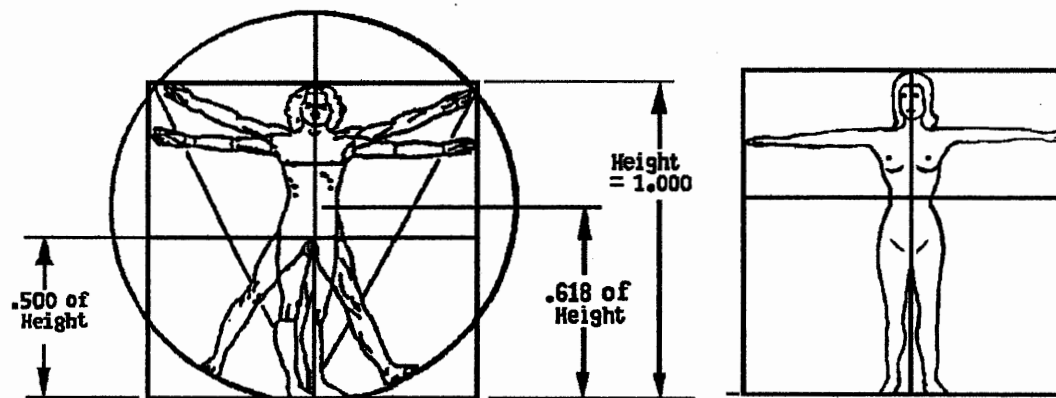

SOME OF THE "CLASSIC" PROPORTIONS: A person eight times as tall as the head, with many .618 or golden section" proportions... For further research, a person can look up "Fibonacci numbers" and "golden section" in a library or on the internet.

Optimum music, art, sculpture, and architecture down through history have often used Fibonacci numbers and golden section. The ancient Greeks built statues of their racial ideals. The Christian church in the middle ages built some of its cathedrals using golden section proportions...

For music, art, architecture and human proportions...

DEFINITIONS:

Love and marriage...

MARRIAGE: A symbolic union and mutual aid agreement, not only between him and her, and also between his and her extended families and clans. It also tends to empower the entire society...

THE BIBLE: Proverbs says to create an inheritance for your children's children.

INDIAN CULTURE: Says to plan ahead for seven generations.

JAPANESE CULTURE: Plans ahead 300 years.

SEX: Is like a high powered motor, which needs the stability of motor mounts and a car frame - symbolizing marriage and morality - to keep the motor from bouncing around the floor and bumping into things when it is revved up.

SEX OUTSIDE MARRIAGE: Is cheap, amoral, increases disease, crime, war, alcohol and drug addiction. Some civilizations may have gone extinct from STD's; some nations now have a 40 percent AIDS rate...

CHILDREN OUT OF WED-LOCK: Have substantially increased chances of social problems by university study. Are more likely to be poor, in prison, socially dysfunctional, are less likely to be employed...

MARRIAGE: A loving, friendship oriented, life-time public union of a male and female for friendship, romance, companionship, business, politics, and mutual aid, and contributing to and hopefully improving the gene pool...

LOVE: There are infinite variations which take a life-time to explore: spiritual, emotional, material...

...go together like a horse and carriage

DEFINITIONS:

THE “LOVE-BOMB” IN NATURE

THE BIBLE: “God is love”, and God is an explosion from which “heaven and earth are blown away”, and putting these two together gives us the phrase “love-bomb”. Is there anything similar in nature?

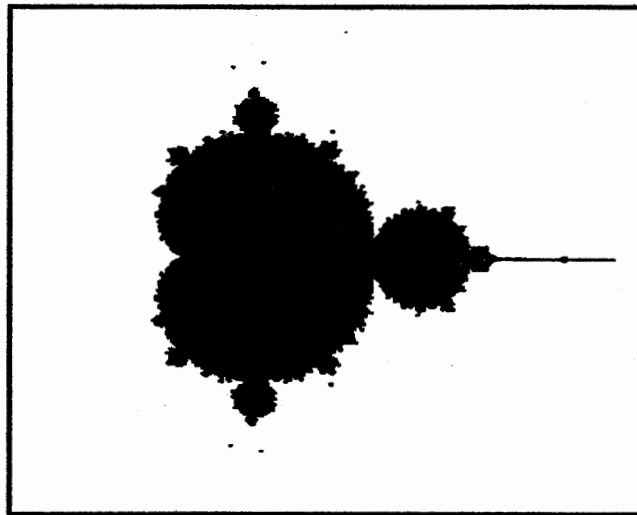

THE MANDELBROT SET: The most complicated equation and geometric pattern ever discovered, and central to much of natural reality, is shaped like a heart with a circle below it, a “circle of love”, if a person has an over-active imagination, and similar to the phrase “God is love”, by amazing coincidence.

GLOBAL SCALAR THEORY: Is a somewhat complex subject, but includes the concept that much of material reality follows the patterns of an explosive “shock wave”, as in the clustering of prime numbers. A typical phrase pulled at random off the internet is, “Moreover, gravitational waves, and even shock ones, can exist...”

THE “LOVE-BOMB” IN NATURE: Combining the circle and heart shape of the Mandelbrot set with the explosive shock waves of global scalar theory, with an active imagination, also gives us a “love-bomb” pattern, similar to the Bible...